



Rivet Racking Systems

Offers incredible value for money, whilst offering amazing strength and rigidity.

The system is simple to build with all parts being tapped together by a rubber mallet. All components are joined via the heavy duty rivet and key hole slot which offers a simple and effective way to assemble the racking.

There are no nuts and bolts and the bays need no bracing therefore offering uninterrupted access on all four sides. Bays are available in various heights up to 3660mm high.

With the average time to assemble a bay being just 5 minutes, you will be amazed at how easy it is to create large installations in no time at all. All bays are ready for immediate dispatch and will be delivered in 5 working days.

- ★ **Best Selling system**
Offers the widest choice of sizes, all at great value
- ★ **Easy to build and re-configure**
Simply tap together with a rubber mallet
- ★ **Strong and sturdy**
With shelf capacities up to 600kgs, it easily copes with heavy goods
- ★ **No nuts, bolts or screws**
Simple and quick to erect, with no fuss
- ★ **Strong epoxy paint finish**
Designed to give years of service and withstand heavy use
- ★ **Will suit any application**
Versatile and expandable, suits a wide range of industries
- ★ **Guaranteed delivery in 5 days**
There when you need it, without fail

scan for
videos | assembly



storagecatalogue.co.uk
/rivet



Heavy & Medium Rivet

Incredible value for money, amazing strength and rigidity. All bays come with 4 levels which have a central deck support on bays 1220mm to 2135mm wide, whilst 2440mm wide bays have two per level, providing that secret strength to all our Rivet bays.

Height	Levels	Shelf Load	Bay Load	Delivery
1830+ mm	4+ Shelves	~600 kg	~2800 kg	5 days



Z Rivet

The "Z" profile rivet system offers a robust effective storage solution for any application. The "Z" profile beam offers incredible strength with a shelf height of only 54mm. Bays are available in various heights up to 3660mm high, three widths and five shelf depths.

Height	Levels	Shelf Load	Bay Load	Delivery
1830+ mm	5+ Shelves	~300 kg	~2800 kg	5 days

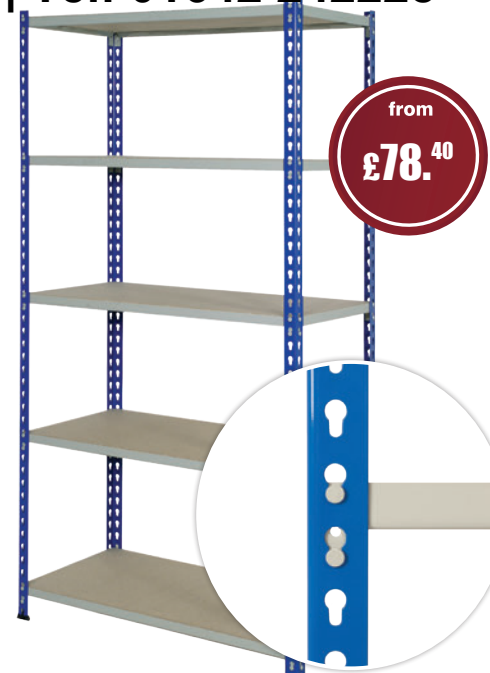

J Rivet

Our J rivet system has unbeatable strength at an incredible price. It is also manufactured to the highest quality. The shallow J beam profile (only 30mm thick) gives increased storage capacity whilst maintaining excellent strength.

Height	Levels	Shelf Load	Bay Load	Delivery
1830+ mm	5+ Shelves	~150 kg	~2800 kg	5 days



Heights	Widths	Depths	Application	Construction	Loadings
Standard Bay Height (mm) 1830 Other Available Heights (mm) 2135, 2440, 2745, 3050, 3660 <i>Uprights can be cut to a specific size</i>	J Rivet Widths (mm) 915, 1220 Z Rivet Widths (mm) 915, 1220, 1525 Heavy Rivet Widths (mm) 915, 1220, 1525, 1830, 2135, 2440	J Rivet Depths (mm) 305, 457, 610 Z Rivet Depths (mm) 305, 457, 610, 762, 915 Heavy Rivet Depths (mm) 305, 457, 610, 762, 915, 1220	Environment Warehouse, Storeroom, Workshop Usage Multipurpose Storage, Heavy & Bulky Items, Archiving, Garment Storage, Reel Storage	Uprights: Steel Blue RAL5010 Beams: Steel Grey RAL7038 **Orange RAL2002 Shelves/Decks Chipboard 15-18mm **Heavy Rivet Only	J Rivet Shelf UDL 120-150kg Z Rivet Shelf UDL 200-300kg Heavy Rivet Shelf UDL 230-600kg Max Bay Load up to 2800kg

Design and plan your Rivet Racking layout

Best for Warehouse, Storeroom or Workshop | up to 600kg UDL/shelf

RIVET RACKING GUIDE

Calculating Exact Dimensions of the Bay & Run of Bays

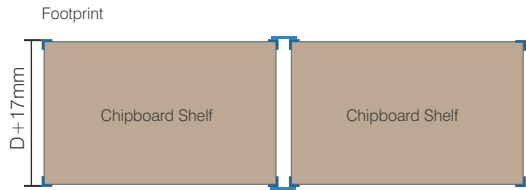
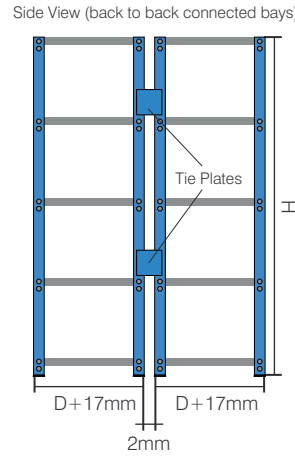
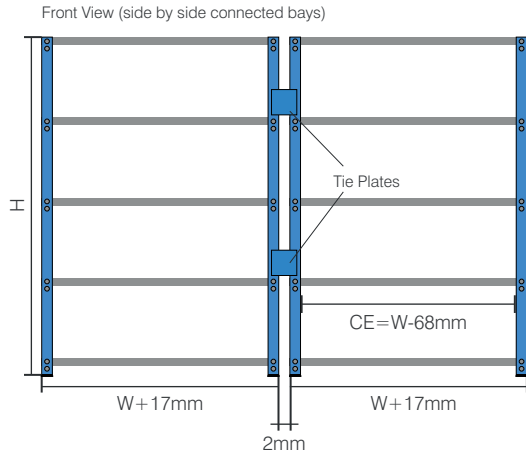

- H** Nominal Height*
- W** Nominal Width*
- D** Nominal Depth*
- CE** Clear Entry between uprights

* Dimensions used in price tables

Rivet Racking Bay Loading (kgs)

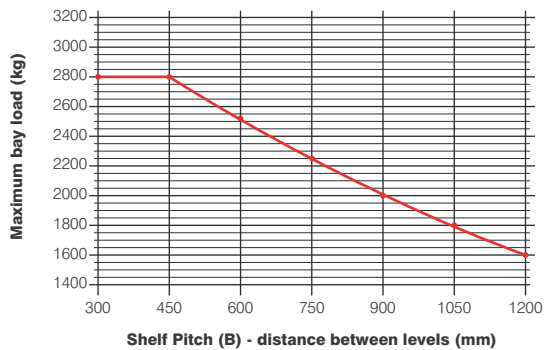

Rivet Upright

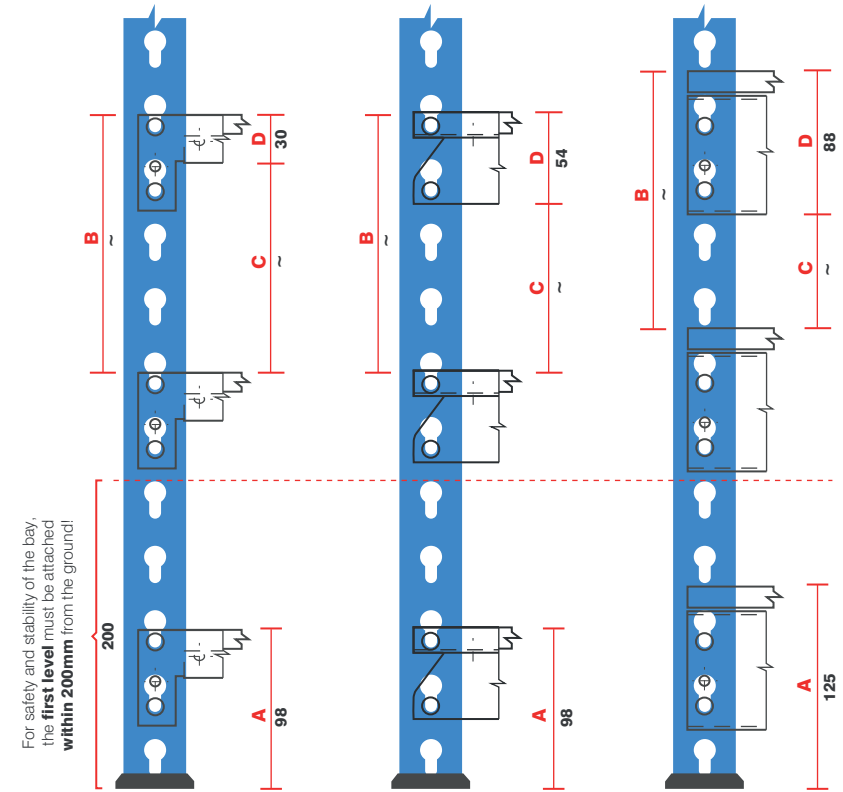
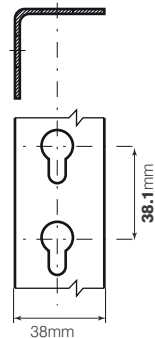

	J Rivet	Z Rivet	Heavy Rivet
A	98mm	98mm	125mm
B	see below ⓘ how to calculate exact Shelf Pitch		
C	B minus D	B minus D	B minus D
D	30mm	54mm	88mm

- A** Minimum First Shelf Level Height
- B** Shelf Pitch - Distance between levels
- C** Clear Entry - Useable space between shelf levels
- D** Shelf Thickness - Beam and chipboard

ⓘ How can you calculate exact Shelf Pitch (B)

Height of item stored + Shelf Thickness divided by **38.1**
= Round decimal up to the next whole number and multiply by **38.1**

e.g. 320mm (Height of stored items) + 88mm (Heavy Rivet) / 38.1
= 10.7 rounded to 11 x 38.1 = 419.1mm Shelf Pitch

ⓘ We have multiple solutions to different storage problems, if you are unsure what's best for you, please contact us.

Rivet Racking accessories and components

1. J Rivet Beam

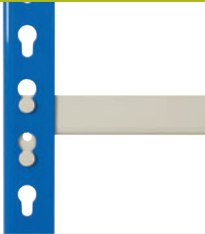

Decking is flush with the top of the beam

2. Notched Side Beam

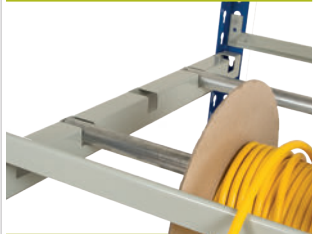

Used with tubes to create rails

3. Rivet Upright



Uprights can be up to 3660mm high

4. Tie Plate

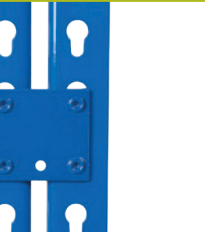

Connects two bays together



3

2

1

4

5

6

7

8

9

10

11

12

12. Deck Support



Adds strength to shelf levels

11. Wall Bracket



Allows the bay to be wall fixed

10. Chipboard Deck



Rivet Racking uses 15mm and 18mm decks

5. Plastic Feet



6. Z Rivet Beam



7. Metal Foot



8. Heavy Rivet Beam



9. Tray Shelf



9. Tray Shelf

Reversed medium rivet 'L' beams





ⓘ Rivet Racking can be further enhanced with mobile accessories, providing another range of solutions. See pages 76-77 for more.



Industrial racking for any application



Rivet Racking 1830 x 2440 x 610mm Blue/Orange +Deck Support Detail

Rubber Mallet  MALLET £3.50	Tie Plate  RR8/SET4 Set of 4 £3.60	Wall Bracket  RR5/WBKT £1.00	Metal Feet  RR5/SET4 Set of 4 £4.00	Floor Fixing  FFM8 M8x50 £0.90
-----------------------------------------------------------------------------------------------------------------------------	------------------------------------------------------------------------------------------------------------------------------------	------------------------------------------------------------------------------------------------------------------------------	--------------------------------------------------------------------------------------------------------------------------------------	----------------------------------------------------------------------------------------------------------------------------------

i If you'd like the Heavy Rivet in blue/orange, use code 'BO' when placing the order.

Heavy Duty Rivet Racking

Heavy duty industrial racking that meets the demands of any warehouse, storeroom and workshop. Quick deliveries and ease of assembly ensures your storage problems will be solved in no time at all.

Rivet Racking offers incredible value for money with amazing strength and rigidity. The quality of the materials used and robust construction ensures it will meet the rigors of the toughest workplace.

The vast range of bay sizes allows for a solution to meet your storage needs and the available space. Flexibility of wide open bays and large shelf capacities enable products of varying weights and dimensions to be easily stored within a single system.

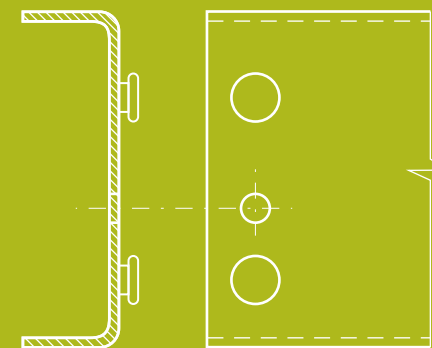

Heavy Rivet beam profile

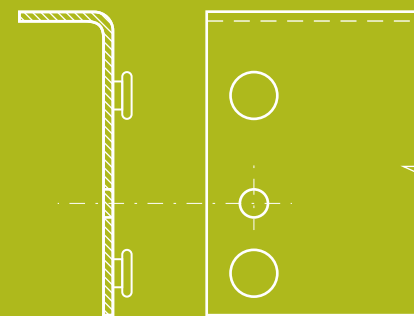

Medium Rivet beam profile

Wide open bays with heavy duty shelves

Wide Open Bays					+ Add Extra Shelves	
	H x W x D (mm)	Bay Code	Shelf Load (kg)	Bay Price	Shelf Code	Additional Shelf Price
W915mm	1830 x 915 x 305	RRB/18/09/03/4	600	£87.30	RRS/09/03	£14.75
	1830 x 915 x 457	RRB/18/09/04/4	600	£97.70	RRS/09/04	£17.35
	1830 x 915 x 610	RRB/18/09/06/4	600	£107.90	RRS/09/06	£19.85
	1830 x 915 x 762	RRB/18/09/07/4	600	£127.25	RRS/09/07	£24.75
	1830 x 915 x 915	RRB/18/09/09/4	600	£147.40	RRS/09/09	£29.80
W1220mm	1830 x 915 x 1220	RRB/18/09/12/4	600	£174.40	RRS/09/12	£36.50
	1830 x 1220 x 305	RRB/18/12/03/4	550	£108.80	RRS/12/03	£20.10
	1830 x 1220 x 457	RRB/18/12/04/4	550	£122.65	RRS/12/04	£23.60
	1830 x 1220 x 610	RRB/18/12/06/4	550	£155.00	RRS/12/06	£31.65
	1830 x 1220 x 762	RRB/18/12/07/4	550	£162.40	RRS/12/07	£33.50
W1525mm	1830 x 1220 x 915	RRB/18/12/09/4	550	£186.90	RRS/12/09	£39.65
	1830 x 1220 x 1220	RRB/18/12/12/4	550	£224.55	RRS/12/12	£49.05
	1830 x 1525 x 305	RRB/18/15/03/4	500	£122.25	RRS/15/03	£23.50
	1830 x 1525 x 457	RRB/18/15/04/4	500	£136.10	RRS/15/04	£26.95
	1830 x 1525 x 610	RRB/18/15/06/4	500	£168.45	RRS/15/06	£35.05
W1830mm	1830 x 1525 x 762	RRB/18/15/07/4	500	£191.55	RRS/15/07	£40.80
	1830 x 1525 x 915	RRB/18/15/09/4	500	£214.15	RRS/15/09	£46.40
	1830 x 1525 x 1220	RRB/18/15/12/4	500	£257.35	RRS/15/12	£57.25
	1830 x 1830 x 305	RRB/18/18/03/4	500	£163.80	RRS/18/03	£33.85
	1830 x 1830 x 457	RRB/18/18/04/4	500	£183.85	RRS/18/04	£38.85
W2135mm	1830 x 1830 x 610	RRB/18/18/06/4	500	£205.40	RRS/18/06	£44.25
	1830 x 1830 x 762	RRB/18/18/07/4	500	£226.60	RRS/18/07	£49.55
	1830 x 1830 x 915	RRB/18/18/09/4	500	£255.95	RRS/18/09	£56.90
	1830 x 1830 x 1220	RRB/18/18/12/4	500	£304.25	RRS/18/12	£68.95
	1830 x 2135 x 305	RRB/18/21/03/4	450	£185.30	RRS/21/03	£39.25
W2440mm	1830 x 2135 x 457	RRB/18/21/04/4	450	£214.65	RRS/21/04	£46.60
	1830 x 2135 x 610	RRB/18/21/06/4	450	£232.40	RRS/21/06	£51.00
	1830 x 2135 x 762	RRB/18/21/07/4	450	£256.65	RRS/21/07	£57.10
	1830 x 2135 x 915	RRB/18/21/09/4	450	£288.75	RRS/21/09	£65.10
	1830 x 2135 x 1220	RRB/18/21/12/4	450	£339.80	RRS/21/12	£77.85
W2745mm	1830 x 2440 x 305	RRB/18/24/03/4	400	£209.30	RRS/24/03	£45.20
	1830 x 2440 x 457	RRB/18/24/04/4	400	£237.45	RRS/24/04	£52.30
	1830 x 2440 x 610	RRB/18/24/06/4	400	£264.30	RRS/24/06	£58.95
	1830 x 2440 x 762	RRB/18/24/07/4	400	£294.55	RRS/24/07	£66.55
	1830 x 2440 x 915	RRB/18/24/09/4	400	£331.30	RRS/24/09	£75.70
W3050mm	1830 x 2440 x 1220	RRB/18/24/12/4	400	£388.30	RRS/24/12	£90.00



+ For Taller Bays Add Price

Extra Height	Code	Price
Bays 2135mm	RRB/21/--/--/4	£4.40
Bays 2440mm	RRB/24/--/--/4	£9.05
Bays 2745mm	RRB/27/--/--/4	£13.65
Bays 3050mm	RRB/30/--/--/4	£18.90
Bays 3660mm	RRB/36/--/--/4	£27.10

Available Heights (mm) (width shown 915mm)

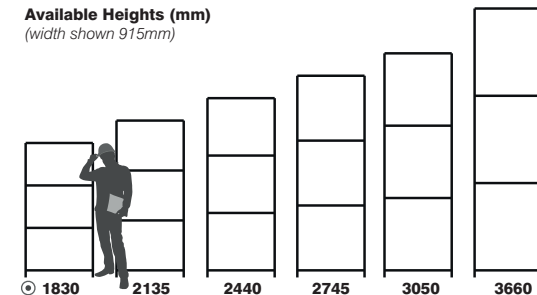

Price includes uprights, plastic feet, face and side beams, deck supports* and chipboard decks for all levels (*except 915mm wide).

Rivet Racking uses a central deck support which not only supports the chipboard panel but ties the front and back beams together.



HEAVY RIVET

Our best value Rivet Racking



Medium Duty Rivet 1830 x 1830 x 610mm

Medium Rivet Bays				+ Adding Extra Shelf	
H x W x D (mm)	Bay Code	Shelf Load (kg)	Bay Price	Shelf Code	Additional Shelf Price
1830 x 1830 x 305	MRB/18/18/03/4	300	£135.60	MRS/18/03	£26.80
1830 x 1830 x 457	MRB/18/18/04/4	300	£155.75	MRS/18/04	£31.85
1830 x 1830 x 610	MRB/18/18/06/4	300	£177.20	MRS/18/06	£37.20
1830 x 1830 x 762	MRB/18/18/07/4	280	£198.45	MRS/18/07	£42.55
1830 x 1830 x 915	MRB/18/18/09/4	250	£227.75	MRS/18/09	£49.85
1830 x 1830 x 1220	MRB/18/18/12/4	230	£276.05	MRS/18/12	£61.90

Price includes uprights, plastic feet, face and side beams, deck supports and chipboard decks

Medium Duty Rivet

Our Medium Rivet uses a lighter 1830mm “L” shape face beam that offers loads up to 300kgs. This provides a more cost effective solution for storing long or bulky items.

The bays are available in depths from 305mm to 1220mm deep and any of the standard upright heights from the Heavy duty range.

The uprights are blue and beams are light grey and each level comes with a central deck support and 18mm chipboard decking.

Height	Levels	Shelf Load	Bay Load	Delivery
1830+ mm	4+ Shelves	230-300 kg	~2800 kg	5 days

Available Heights (mm)

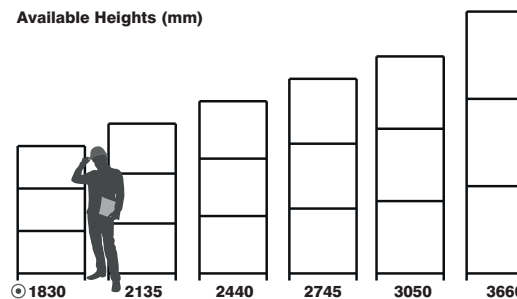

+ For Taller Bays Add Price		
Extra Height	Code	Price
Bays 2135mm	ZRB/21/--/--/5	£4.40
Bays 2440mm	ZRB/24/--/--/5	£9.05
Bays 2745mm	ZRB/27/--/--/5	£13.65
Bays 3050mm	ZRB/30/--/--/5	£18.90
Bays 3660mm	ZRB/36/--/--/5	£27.10

Rubber Mallet

MALLET **£3.50**

Tie Plate

RR8/SET4 Set of 4 **£3.60**

Wall Bracket

RR5/WBKT **£1.00**

Metal Feet

RR5/SET4 Set of 4 **£4.00**

Floor Fixing

FFM8 M8x50 **£0.90**

Remember, if your shelving height to depth ratio is greater than 4:1, the bay should be fixed to the floor or to the wall.

Z Rivet Compartment Bays

Create compartments to store awkward items

Z Rivet compartment bays provide an effective way to store loose or awkward items. The bays provide multiple locations for separating individual products which enable for faster picking.

The system uses our standard Z Rivet shelving components with bespoke shelves, dividers and cladding. This creates a cost effective compartment system with strength and ease of installation.

We have designed a range of standard bays, which are all stocked and delivered within 5 days. As well as standard bays we can offer bespoke designs so please call to discuss your requirements.

Height	Levels	Shelf Load	Bay Load	Delivery
1830+ mm	5+ Shelves	45kg /position	~2800 kg	5 days



© Z Rivet Compartment Bay 1830 x 915 x 457 mm with two dividers

from
£148.³⁰



Z Rivet Compartment Bay 1830 x 915 x 457 mm with two dividers with added two side clads, bin fronts & bin backs on each level

Z Rivet Compartment Bays			+Add Extra Shelves		+Add Side Cladding (1830mm high)			+Add Bin Fronts		+Add Bin Backs		
	H x W x D (mm)	Bay Code	Bay Price	Shelf Code	Shelf Price	H x D (mm)	Code	Price	Code	Price	Code	Price
W915mm	c/w 2 vertical dividers								Height 60mm		Height 200mm	
	1830 x 915 x 305	ZRCB/18/09/03/5	£148.30	ZRCS/09/03	£20.35	1830 x 305	ZRC/18/03/SC	£9.25				
	1830 x 915 x 457	ZRCB/18/09/04/5	£186.20	ZRCS/09/04	£26.05	1830 x 457	ZRC/18/04/SC	£13.85	ZRC/09/006/BF	£1.85	ZRC/09/020/BB	£4.50
	1830 x 915 x 610	ZRCB/18/09/06/5	£214.30	ZRCS/09/06	£31.65	1830 x 610	ZRC/18/06/SC	£18.50				
W1220mm	c/w 3 vertical dividers								Height 60mm		Height 200mm	
	1830 x 1220 x 305	ZRCB/18/12/03/5	£187.35	ZRCS/12/03	£26.25	1830 x 305	ZRC/18/03/SC	£9.25				
	1830 x 1220 x 457	ZRCB/18/12/04/5	£237.15	ZRCS/12/04	£33.45	1830 x 457	ZRC/18/04/SC	£13.85	ZRC/12/006/BF	£2.50	ZRC/12/020/BB	£5.75
	1830 x 1220 x 610	ZRCB/18/12/06/5	£286.80	ZRCS/12/06	£40.60	1830 x 610	ZRC/18/06/SC	£18.50				

(i) Price includes uprights, plastic feet, perimeter beams, shelf supports (where necessary), MDF decks and vertical dividers. MDF side cladding, bin fronts and bin backs are purchased extra.

(i) Two adjoining compartment bays can share a single side cladding! Bespoke designs available, please call us to discuss your requirements.



Incredible strength with a low profile beam



● Z Rivet Bay 1830 x 915 x 457 mm +Detail on deck support and rivet connection

● Z Rivet Bay 1830 x 915 x 915 mm with Rhino Tuff Bins – more on p.102

Z Rivet Racking

Our "Z" profile rivet system offers a robust and effective storage solution for any application.

The "Z" profile beam offers incredible strength with a shelf height of only 54mm. The system requires only a rubber mallet to build and just taps together. There are no nuts and bolts and the bays need no bracing therefore offering **uninterrupted access on all four sides**.

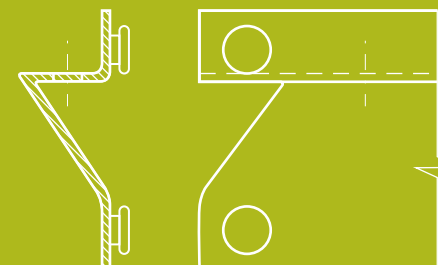

Bays are available in various heights up to 3660 high, three widths to 1525mm and five shelf depths to 915mm.



Z Rivet beam profile

Best for Warehouse, Storeroom or Workshop | up to 300kg UDL/shelf

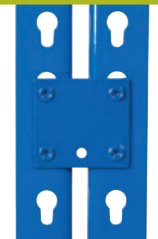
Z RIVET RACKING

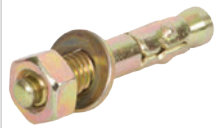
Rubber Mallet	Tie Plate	Wall Bracket	Metal Feet	Floor Fixing
				
MALLET £3.50	RR8/SET4 Set of 4 £3.60	RR5/WBKT £1.00	RR5/SET4 Set of 4 £4.00	FFM8 M8x50 £0.90

ⓘ For Rivet racks with heavy duty storage bins, please see page 102-103.

High density storage with access on all four sides



Z Rivet Bays				+ Add Extra Shelf		
	H x W x D (mm)	Bay Code	Shelf Load (kg)	Bay Price	Shelf Code	Additional Shelf Price
W915mm	1830 x 915 x 305	ZRB/18/09/03/5	300	£99.75	ZRS/09/03	£14.30
	1830 x 915 x 457	ZRB/18/09/04/5	300	£112.75	ZRS/09/04	£16.85
	1830 x 915 x 610	ZRB/18/09/06/5	300	£125.45	ZRS/09/06	£19.45
	1830 x 915 x 762	ZRB/18/09/07/5	300	£163.30	ZRS/09/07	£24.30
	1830 x 915 x 915	ZRB/18/09/09/5	300	£192.15	ZRS/09/09	£29.55
W1220mm	1830 x 1220 x 305	ZRB/18/12/03/5	250	£119.40	ZRS/12/03	£18.25
	1830 x 1220 x 457	ZRB/18/12/04/5	250	£134.65	ZRS/12/04	£21.25
	1830 x 1220 x 610	ZRB/18/12/06/5	250	£150.00	ZRS/12/06	£24.30
	1830 x 1220 x 762	ZRB/18/12/07/5	250	£192.75	ZRS/12/07	£32.90
	1830 x 1220 x 915	ZRB/18/12/09/5	250	£224.50	ZRS/12/09	£39.25
W1525mm	1830 x 1525 x 305	ZRB/18/15/03/5	200	£139.30	ZRS/15/03	£22.15
	1830 x 1525 x 457	ZRB/18/15/04/5	200	£156.95	ZRS/15/04	£25.75
	1830 x 1525 x 610	ZRB/18/15/06/5	200	£188.70	ZRS/15/06	£32.10
	1830 x 1525 x 762	ZRB/18/15/07/5	200	£228.55	ZRS/15/07	£40.00
	1830 x 1525 x 915	ZRB/18/15/09/5	200	£258.00	ZRS/15/09	£45.95

+ For Taller Bays Add Price

Extra Height	Code	Price
Bays 2135mm	ZRB/21/--/--/5	£4.40
Bays 2440mm	ZRB/24/--/--/5	£9.05
Bays 2745mm	ZRB/27/--/--/5	£13.65
Bays 3050mm	ZRB/30/--/--/5	£18.90
Bays 3660mm	ZRB/36/--/--/5	£27.10

Available Heights (mm)

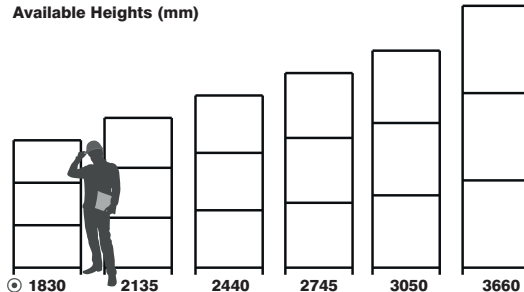

⊙ Z Rivet Bay 1830 x 1525 x 915mm



Height
1830+ mm



Levels
5+ Shelves



Shelf Load
200-300 kg



Bay Load
~2800 kg



Delivery
5 days

from
£99.⁷⁵

ⓘ Price includes uprights, plastic feet, perimeter beams, deck supports (762-915mm deep) and chipboard decks for all levels

ⓘ Rivet Racking uses a central deck support which not only supports the chipboard panel but ties the two face beams together.



Our lowest priced Rivet Shelving system

J Rivet

Low cost shelving system

Our J rivet system has unbeatable strength at an incredible price. It is also manufactured to the high quality you have come to expect from one of the UK's leading suppliers.

The shallow J beam profile gives increased storage capacity whilst maintaining excellent strength. It is also compatible with the Z and Heavy rivet systems to increase its flexibility within any installation. The bays are available in six heights, two widths and three depths making space planning of any area simple and effective.

The system is simple to erect yet has all the strength you are likely to need. The bays just tap together with a rubber mallet so you can organize your storage in a fraction of the time it can take with more traditional systems.

With the average time to assemble a bay being just 5 minutes, you will be amazed at how easy it is to create large installations in no time.

All bays are ready for immediate despatch and will be delivered in 5 working days.



Run of J Rivet bays connected with Tie Plates

Rubber Mallet	Tie Plate	Wall Bracket	Metal Feet	Floor Fixing
MALLET £3.50	RR8/SET4 Set of 4 £3.60	RR5/WBKT £1.00	RR5/SET4 Set of 4 £4.00	FFM8 M8x50 £0.90

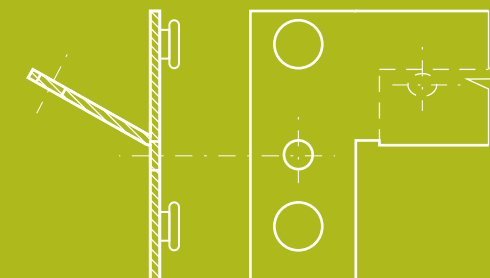

J Rivet beam profile

i J Rivet increases storage density with its 30mm slim beam profile.

Strong, sturdy and simple to build



J Rivet Bays				+Add Extra Shelf		
	H x W x D (mm)	Bay Code	Shelf Load (kg)	Bay Price	Shelf Code	Additional Shelf Price
W915mm	1830 x 915 x 305	JRB/18/09/03/5	150	£78.40	JRS/09/03	£10.00
	⊙ 1830 x 915 x 457	JRB/18/09/04/5	150	£89.65	JRS/09/04	£12.25
	1830 x 915 x 610	JRB/18/09/06/5	150	£101.20	JRS/09/06	£14.55
W1220mm	1830 x 1220 x 305	JRB/18/12/03/5	120	£91.70	JRS/12/03	£12.65
	1830 x 1220 x 457	JRB/18/12/04/5	120	£105.20	JRS/12/04	£15.40
	1830 x 1220 x 610	JRB/18/12/06/5	120	£119.40	JRS/12/06	£18.25

ⓘ Price includes uprights, plastic feet, face and side beams and chipboard decks for all levels

+For Taller Bays Add Price

Extra Height	Code	Price
Bays 2135mm	JRB/21/-/-/5	£4.40
Bays 2440mm	JRB/24/-/-/5	£9.05
Bays 2745mm	JRB/27/-/-/5	£13.65
Bays 3050mm	JRB/30/-/-/5	£18.90
Bays 3660mm	JRB/36/-/-/5	£27.10

Available Heights (mm)
(width shown 915mm)

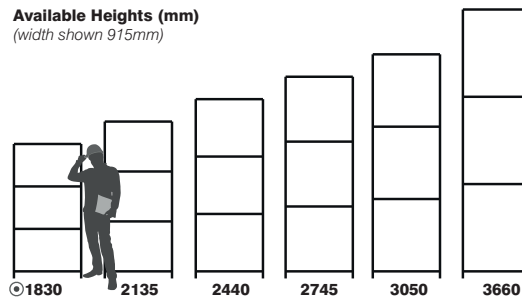

⊙ J Rivet Bay 1830 x 915 x 457mm

Height	Levels	Shelf Load	Bay Load	Delivery
1830+ mm	5+ Shelves	120-150 kg	~2800 kg	5 days

from
£78.40

ⓘ J Rivet gets your storage organized quickly with the parts just being tapped together with a rubber mallet.



Keep cable reels organised

A new solution for organizing and dispensing cable or items stored in reels.

The simple side beam that supports a 25mm diameter tube which can hold a variety of drums or reels. The beam is notched so the tubes can be located in 5 different positions. Each level is then fitted with a face beam to enable the material to be offered to the user and conveniently cut to length.

The units can come as either static racks or as a low level mobile trolley. The bays come either 915 or 1220mm wide and 610mm deep.

Best for Retail, Storeroom or Workshop | up to 70kg UDL/rail

RIVET CABLE REEL RACKS



● Cable Reel Trolley 915 x 915 x 610 mm



5 different positions for the tube



Braked castors for additional safety



● Cable Reel Rack 1830 x 915 x 610 mm

Mobile Cable Reel Storage / Bench

H x W x D (mm)	Code	Tube Load (kg)	Price
915 x 915 x 610	RRCT/09/09/06/2/GY	70	£286.80

① Price includes uprights, welded base frame with swivel castors (2 braked), chipboard decks and two levels with notched beams, support beams and 4 zinc coated tubes



610 mm



4-8 Rails



60-70 kg



5 days

Cable Reel Rack - 1830mm high

H x W x D (mm)	Code	Tube Load (kg)	Price
1830 x 915 x 610	RRCB/18/09/06/4/GY	70	£192.60
1830 x 1220 x 610	RRCB/18/12/06/4/GY	60	£245.70

① Price includes uprights, plastic feet, chipboard decks and four levels with notched beams, support beams and 8 zinc coated tubes

① If you cannot find the right size for your application, please call us for more customised options.

Rivet Garment Racks

The perfect storage solution for any bulk garment hanging requirement. All constructed from Rivet racking components for simplicity and ease of assembly.

The 25mm zinc coated tube slots into place on the notched beams and can be located in five different positions.

This can provide a single rail centrally positioned or two rails located on each face of the rack providing twice the capacity. Each storage level can be adjusted every 38mm easily with just a rubber mallet.



Two single rail garment bays connected with tie plates



Height

2135 mm



Width

~1220 mm



Levels

2-4 Rails



Tube Load

60-70 kg



Delivery

5 days

Bulk garment hanging storage solution



Single Rail Garment Bay 2135 x 915 x 610 mm



Double Rail Garment Bay 2135 x 915 x 610 mm

Single Rail Garment Bay - 2 Levels

H x W x D (mm)	Code	Tube Load (kg)	Bay
2135 x 915 x 610	RRGB/SG/21/09/06/2/GY	70	£82.90
2135 x 1220 x 610	RRGB/SG/21/12/06/2/GY	60	£102.35

Double Rail Garment Bay - 2 Levels

H x W x D (mm)	Code	Tube Load (kg)	Bay
2135 x 915 x 610	RRGB/DG/21/09/06/2/GY	70	£101.50
2135 x 1220 x 610	RRGB/DG/21/12/06/2/GY	60	£130.60

Price includes uprights, plastic feet, chipboard decks for top and bottom shelves, two levels with notched beams, support beams and 2 or 4 zinc coated tubes

Need wider heavy duty garment rails? See our Longspan garment solution on p.62.



Utilise space with our high density Archive solution



● Double Box Deep Rivet Archive 3050 x 1830 x 915 with 100 boxes on 5 levels

Best for Warehouse, Storeroom or Office | up to 500kg UDL/shelf

RIVET RACKING ARCHIVE

Rubber Mallet



MALLET £3.50

Tie Plate



RR8/SET4 Set of 4 £3.60

Wall Bracket



RR5/WBKT £1.00

Metal Feet



RR5/SET4 Set of 4 £4.00

Floor Fixing



FFM8 M8x50 £0.90

Archive Storage Solutions

With the continuing demand to store paper for all businesses, the need for a high density solution will be easily solved with our Heavy Duty Rivet Racking system.

Rivet Racking will provide a cost effective and flexible way to solve any archive storage problem. This type of storage shelving is simple to adapt with add-on bays or extra levels. This way you can create a simple solution that utilises the space available.

By using standard shelving units that come complete with our heavy duty archive boxes, you have a ready made solution. This will ensure documents are well organised and easily accessible, allowing the user to locate and retrieve files quickly.

Need More Boxes?

Our Heavy Duty Archive box and lid are designed to hold 20kgs of paper. The robust construction means documents will be securely and safely stored. The boxes come flat packed and are easy to assemble. Boxes come with handle holes for easy transportation and the internal dimensions are 260H x 330W x 390D.



Archive Boxes – Pack Of 10

H x W x D (mm)	Code	Price
270 x 350 x 430	AK0020AB/10	£25.00

ⓘ For storing small components, please check our high density storage solutions on p.110.

Rivet Racking Archive Storage

Rivet Archive - 1525mm Wide



	H x W x D (mm)	Shelf Levels	Code	Box Qty	Price
Single Box Deep Depth 457mm	1830x1525x457mm (*1966mm)	3	RRAK15/24	24	£169.65
	2440x1525x457mm (*2614mm)	4	RRAK15/32	32	£225.75
	3050x1525x457mm (*3262mm)	5	RRAK15/40	40	£282.70
Double Box Deep Depth 915mm	1830x1525x915mm (*1966mm)	3	RRAK15/48	48	£288.70
	2440x1525x915mm (*2614mm)	4	RRAK15/64	64	£384.45
	3050x1525x915mm (*3262mm)	5	RRAK15/80	80	£481.05

*Height to top box

Rivet Archive - 1830mm Wide

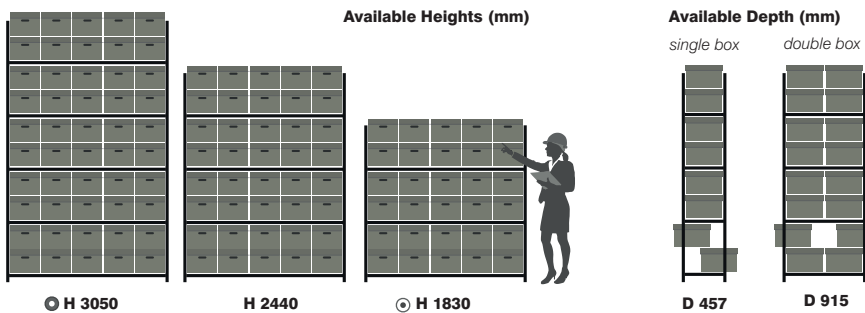





	H x W x D (mm)	Shelf Levels	Code	Box Qty	Price
Single Box Deep Depth 457mm	⊙ 1830x1830x457mm (*1966mm)	3	RRAK18/30	30	£220.60
	2440x1830x457mm (*2614mm)	4	RRAK18/40	40	£293.70
	3050x1830x457mm (*3262mm)	5	RRAK18/50	50	£367.60
Double Box Deep Depth 915mm	1830x1830x915mm (*1966mm)	3	RRAK18/60	60	£350.25
	2440x1830x915mm (*2614mm)	4	RRAK18/80	80	£466.60
	⊙ 3050x1830x915mm (*3262mm)	5	RRAK18/100	100	£573.90

*Height to top box

① Price includes uprights, plastic feet, perimeter beams, deck supports, chipboard decks and archive boxes with lids



⊙ Single Box Deep Rivet Archive 1830 x 1830 x 457 with 30 boxes on 3 levels

 Height 1830+ mm	 Levels 3-5 Shelves	 Shelf Load 400-500 kg	 Bay Load ~2800 kg	 Delivery 5 days
-------------------------------------------------------------------------------------------------------------	----------------------------------------------------------------------------------------------------------------	-------------------------------------------------------------------------------------------------------------------	---------------------------------------------------------------------------------------------------------------	-------------------------------------------------------------------------------------------------------------

from
£169.⁶⁵

① Rivet Racking uses a central deck support which not only supports the chipboard panel but ties the two face beams together.

